

MOLD NO. RFQ NO.: XXXXXX

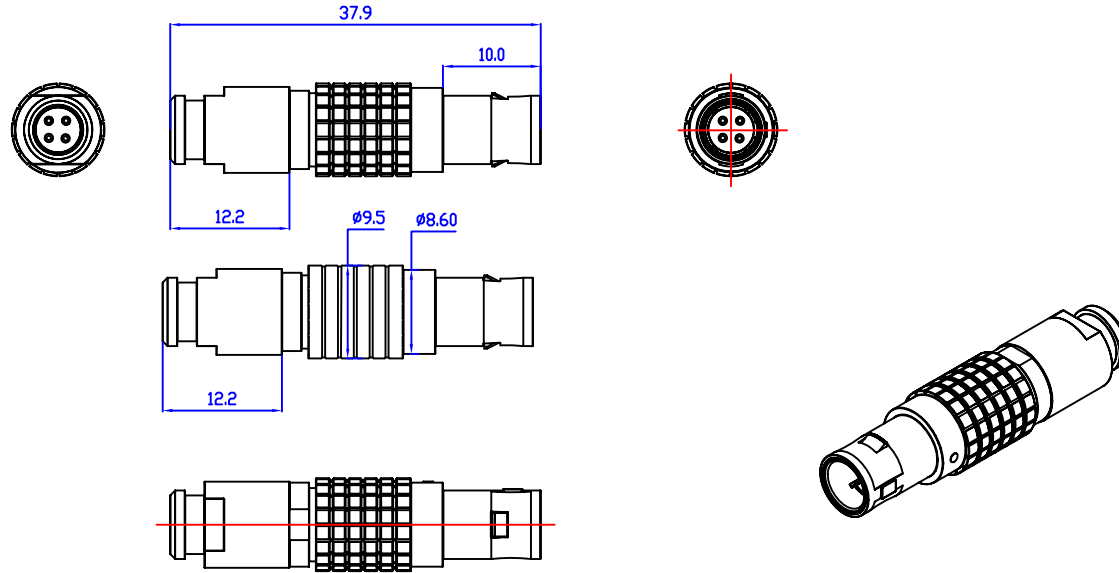

REV.	DESCRIPTION	APPD.	DATE
A	INITIAL RELEASED	WANG	04/24/19'



Electrical Character
 Rating voltage: 30V AC/DC
 Insulation resistance: >100MΩ
 Rating current: 3A
 Contact resistance: ≤5mΩ

General Information
 Standard: IEC 61076-2-104
 Connector Body:
 Contacts: Brass with gold plated
 Connector Locking System: Screw-locking
 Connector Screw: Phosphorus copper with gold plated
 Waterproof Ring: Fluorine rubber ring
 Waterproof Rating: IP67/IP68

<http://jh-com.com> <http://connectors-cable.com>

UNDECLARED TOLERANCE		CUS P/N:	JH-COM			
X. ±0.1	X. ° ±2.0°					
.X ±0.03	.X° ±1.0°	PART NO. : OB00M-XX	TITLE: OB 线端插头 组装图			
.XX ±0.02	.XX° ±0.5°					
UNITS: MM		APPD. :	DWG NO. :			
THESE DRAWINGS AND SPECIFICATIONS ARE THE PROPERTY OF JH-C AND SHALL NOT BE REPRODUCED, COPIED OR USED IN ANY MANNER WITHOUT THE PRIOR WRITTEN CONSENT OF JH-C.		CHKD. :	 	SCALE	SHEET	REV.
		DR. : HWJ_03/11/18'		1:1	1/1	A

ITEM	PART NAME	DESCRIPTION	QTY
------	-----------	-------------	-----

MOLD NO. RFQ NO.: XXXXXX

REV.	DESCRIPTION	APPD.	DATE
A	INITIAL RELEASED	WANG	04/24/19'

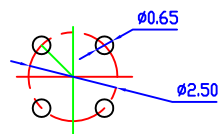
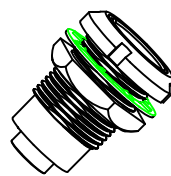
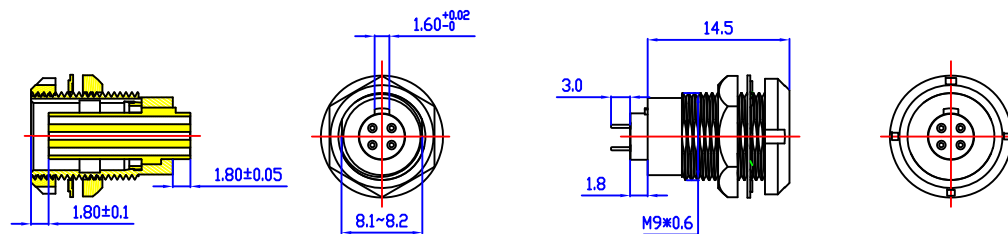

RECOMMENDED P.C.B LAYOUT

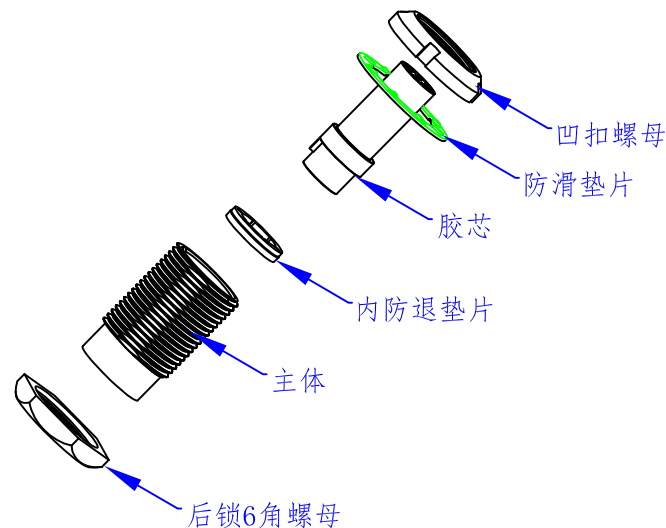

Electrical Character
 Rating voltage: 30V AC/DC
 Insulation resistance: >100MΩ
 Rating current: 3A
 Contact resistance: ≤5mΩ

General Information
 Standard: IEC 61076-2-104
 Connector Body:
 Contacts: Brass with gold plated
 Connector Locking System: Screw-locking
 Connector Screw: Phosphorus copper with gold plated
 Waterproof Ring: Fluorine rubber ring
 Waterproof Rating: IP67/IP68

NOTE:

黄铜镀铬100u" 电底表面无裂光滑
 未注明公差依图框一般公差标准

<http://jh-com.com> <http://connectors-cable.com>

UNDECLARED TOLERANCE		CUS P/N:	JH-COM		
X. ±0.1	X. ° ±2.0°	PART NO. : OB001-XX	TITLE: OB 母座 ECG 组装图		
.X ±0.03	.X ° ±1.0°		DWG NO. :		
.XX ±0.02	.XX ° ±0.5°		SCALE SHEET REV.		
UNITS: MM		APPD. :	1:1 1/1 A		
THESE DRAWINGS AND SPECIFICATIONS ARE THE PROPERTY OF JH-C AND SHALL NOT BE REPRODUCED, COPIED OR USED IN ANY MANNER WITHOUT THE PRIOR WRITTEN CONSENT OF JH-C.		CHKD. :	DR. : HWJ_03/11/18'		

ITEM	PART NAME	DESCRIPTION	QTY
------	-----------	-------------	-----